

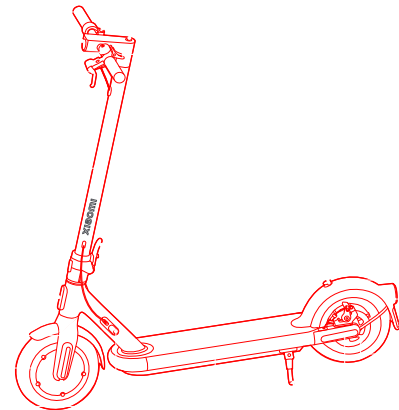

## Product Overview



Handlebar

Brake Lever

Front Fork

Accelerator

Quick Release Lever

Tail Light & Rear Reflector

Side Reflector

Front Light

Stem

Wheel Motor

Control Panel & Power Button

Buckle

License Plate Holder

Kickstand

Scooter Bell

Reflector

Charging Port

Bell Lever

Mudguard

Disc Brake

Battery Compartment





## Control Panel & Power Button



Display the current speed of the scooter, as well as to display error codes.

The icon indicates that the scooter has been successfully connected to the mobile device.

1. When the scooter is not being charged, if the ambient temperature is lower than -10°C or higher than 45°C, the temperature error icon on the control panel will blink. Riding in such circumstances may result in reduced performance of the scooter and other risks. You can use the scooter after the temperature returns to the normal operating range.
2. When the scooter is being charged, if the ambient temperature becomes lower than 0°C or higher than 40°C, the temperature error icon on the control panel will blink and the scooter may become unable to be charged. Continuing charging the scooter may even pose a risk. When the ambient temperature returns to the range of 0°C to 40°C, the temperature error icon will go out and you can charge the scooter again.

Press the button to turn the scooter on, and hold the button for 3 seconds to turn the scooter off. When the scooter is on, press the button to turn on/off the headlight and tail light, and press twice to cycle through the modes.

ⓧ is for pedestrian mode (walking mode), the maximum speed of the scooter is 6 km/h, and the tail light is blinking in this mode (the headlight and the tail light are both on). D is for standard mode, and S for sport mode.

Note: walking mode is for products under eKFV only.

Enable the cruise control function in the Mi Home/Xiaomi Home app. When you are riding the scooter stably, hold the accelerator at the same position until the scooter makes a long beep, then release the accelerator, and the scooter will be in the cruise control mode with the current speed. To disable the mode, press the brake lever or the accelerator, and the scooter will beep twice. Note: For some models only.

Lock the scooter via the Mi Home/Xiaomi Home app.

When the wrench icon displays red, it indicates that the scooter needs repair. When the wrench icon blinks red, it indicates that the scooter has an error.

The battery power is indicated by 5 bars, each representing approximately 20 % of a full battery.



## Package Contents

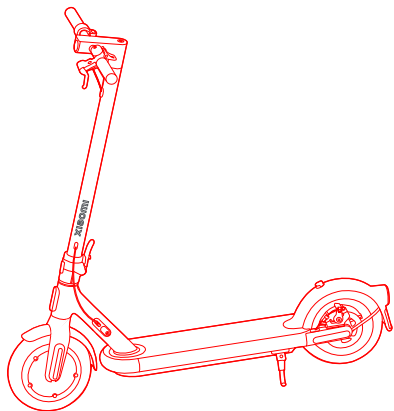

Xiaomi Electric Scooter 4 Pro User Manual

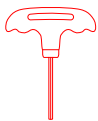

T-shape Allen Key



Extension Nozzle



Important Information



Screw



Xiaomi Electric Scooter 4 Pro Specifications and Certifications

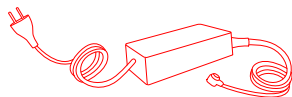

Battery Charger



AC Power Cord (For the UK only)



## Assembly and Set-Up

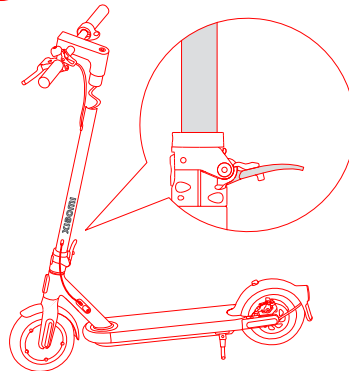

1 Lift the stem up, fasten it, and put down the kickstand.

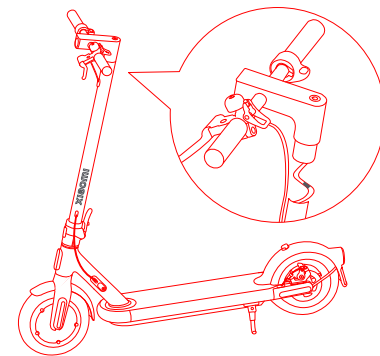

2 Install the handlebar onto the stem.

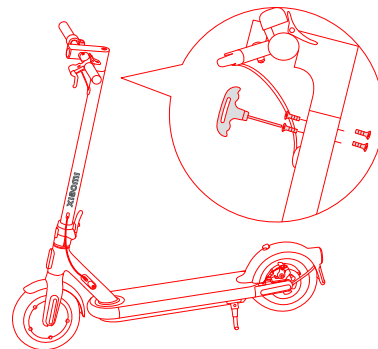

3 Tighten the screws onto both sides of the stem with the T-shaped Allen key.



## Charge Your Scooter

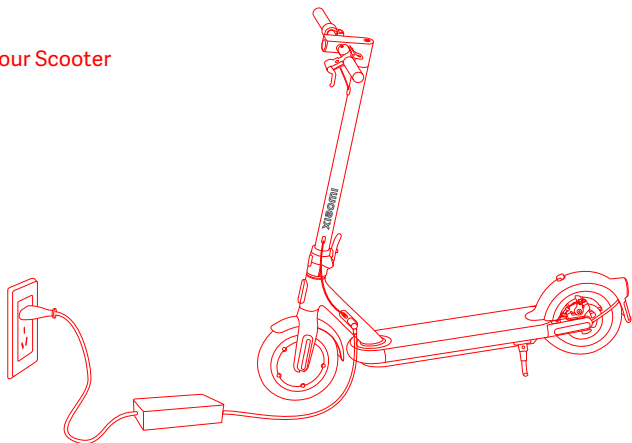

The scooter is fully charged when the LED on the charger changes from red (charging) to green (trickle charge).

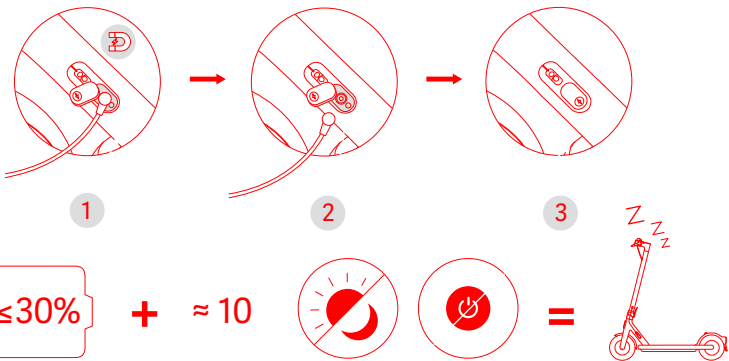

When the battery level is under 30% and the scooter is not powered on for about 10 consecutive days, the battery will enter into sleep mode. If this happens, your scooter cannot be powered on. Please charge it for three seconds to activate the battery.



## Connect with Mi Home

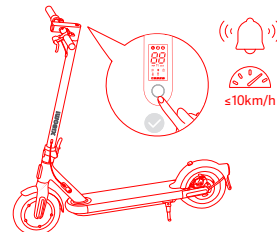

Before being activated, the scooter will keep beeping when turned on and is limited to 10 km/h. Once the scooter is activated, the beeping alarm will stop and the speed restriction will be lifted.

Note: the app is referred to as Xiaomi Home app in Europe (except for Russia). The name of the app displayed on your device should be taken as the default.

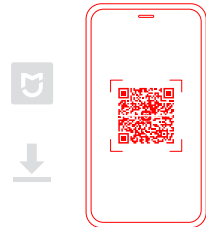

1 Scan the QR code to download and install the app.



2 Open the Mi Home/Xiaomi Home app.

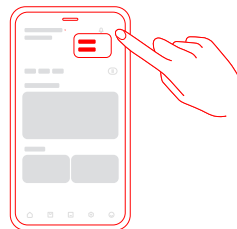

3 Tap "+" on the top right corner, and then select "Add a device" or "Scan".

Note: the version of the app might have been updated, please follow the instructions based on the current app version.

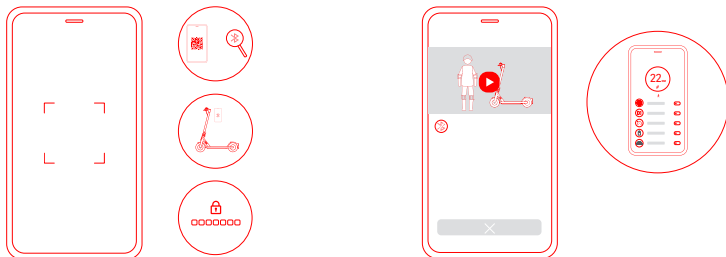

- 4 Follow the instructions to add and pair the scooter. Note: The QR code attached on the control panel is unique to your scooter, please keep this code safe.
- 5 Watch the tutorial for beginners to activate the scooter. Note: Do not exit the tutorial before finishing it. Otherwise, the activation will fail.



## How To Ride



- 1 Warning: Wear a helmet, elbow pads and knee pads. Note: Please check the tire pressure before riding.

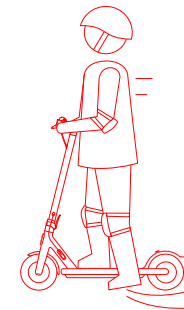

- 2 Step on the deck with one foot, and slowly kicks off the other on the ground.

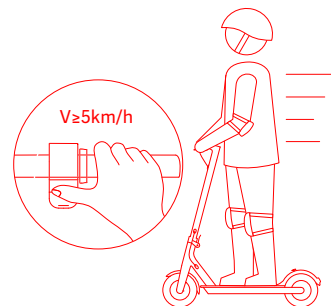

- 3 The accelerator initiates once the coasting speed exceeds 5 km/h.

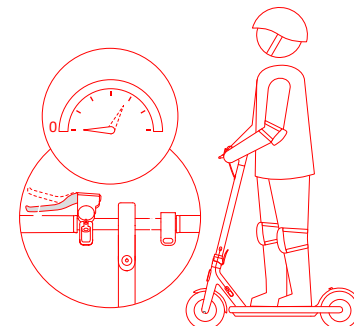

- 4 Release the accelerator and squeeze the brake lever for a sudden brake.

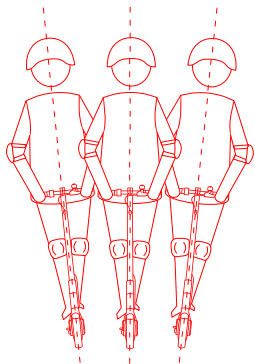

**5** Tilt your body to the steering direction as you turn, and slowly turn the handlebar.

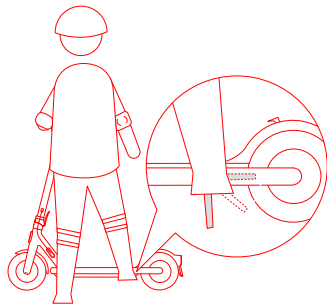

**6** Put down the kickstand when parking.

Watch out for safety risks.

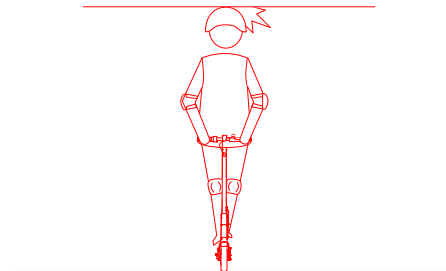

Avoid hitting your head on door frames, elevators, and other overhead obstacles.

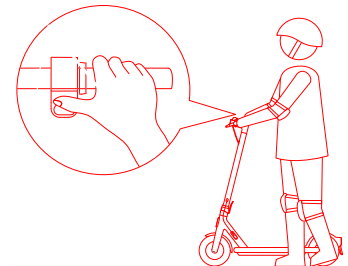

Do not press the accelerator when you're walking alongside the scooter.



Safety Reminder



Always steer clear of obstacles.

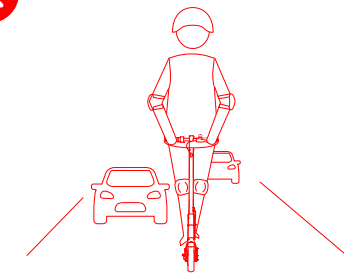

Unless otherwise authorized by the local laws, it is forbidden and illegal to ride on public roads, motorways, and expressways.

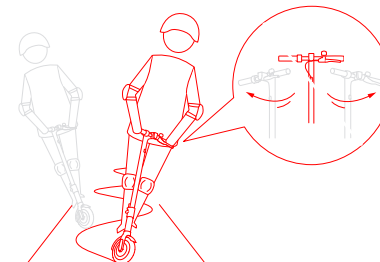

Do not abruptly change the steering direction at high speed.

Do not try dangerous actions.

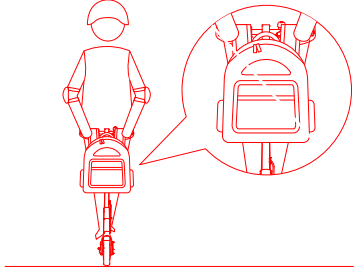

Do not hang bags or other heavy stuff on the handlebar.

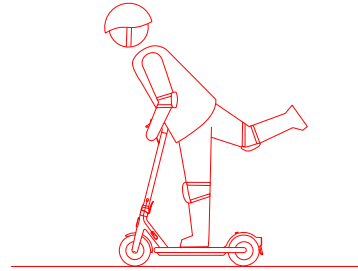

Do not ride on one foot.

Do not try dangerous actions.



Do not ride in the rain. Do not ride through puddles or any other (water) obstacles.

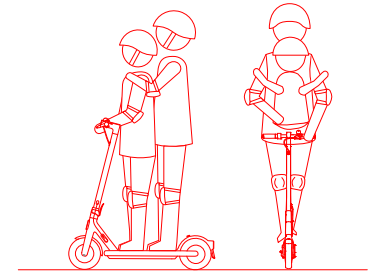

Do not ride with anyone else, including children.

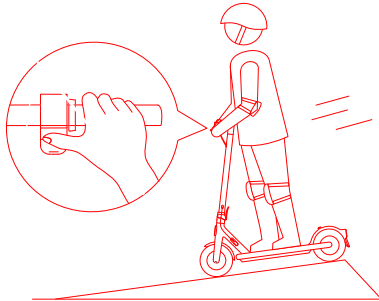

Do not accelerate when going downhill, and brake in time to slow down. When on a steep slope, you need to step off the scooter and push.

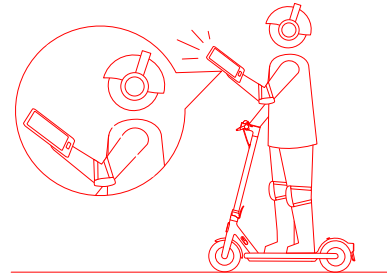

Do not use mobile phone or wear earphones when operating the scooter.

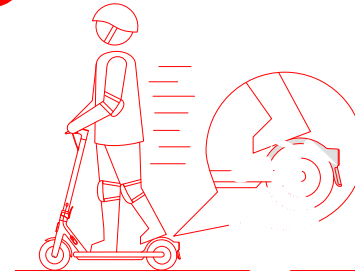

Do not keep your feet on the rear mudguard.

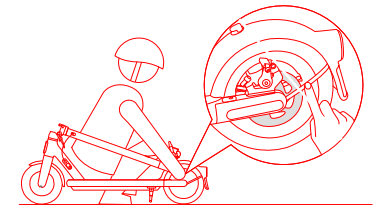

Do not touch the disc brake.

Do not try dangerous actions.

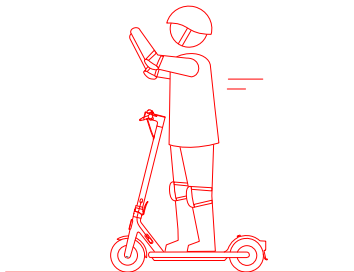

Do not let go of the handlebar while riding.

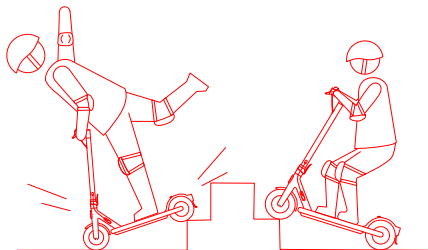

Do not try riding up or down stairs, nor try jumping over obstacles.



## Lock Your Scooter

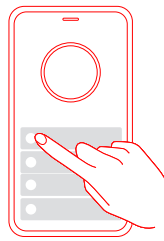

Image 1 Tap Lock the motor

Locking the scooter: Tap Lock the motor in the Mi Home/Xiaomi Home app to lock the scooter as illustrated in Image 1. When the scooter is locked, the motor is locked and all the icons on the control panel will automatically go out except the Bluetooth icon and the lock icon. If the scooter goes beyond the Bluetooth connection range, the Bluetooth will be disconnected and its icon will go out.

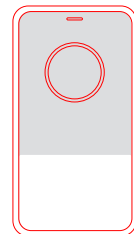

Image 2 Motor locked

Motor Locked: After the motor is locked as illustrated in Image 2, the front wheel of the scooter cannot move normally. The control panel will sound an alarm when someone forcibly pushes the scooter.

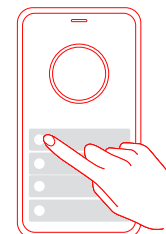

Image 3 Tap Unlock the motor

Unlocking the Scooter: Tap Unlock the motor in the Mi Home/Xiaomi Home app to unlock the scooter as illustrated in Image 3.





## Fold & Carry

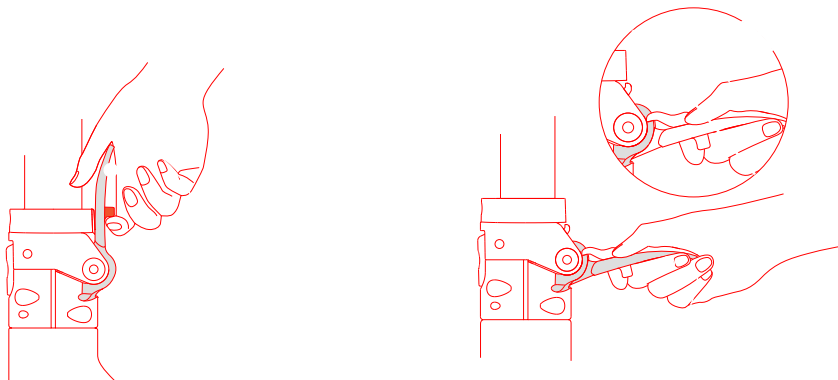

1 Lift the safety lock, and push down the quick release lever.

2 Lift the safety lock and push down the quick release lever again, then fold the stem.

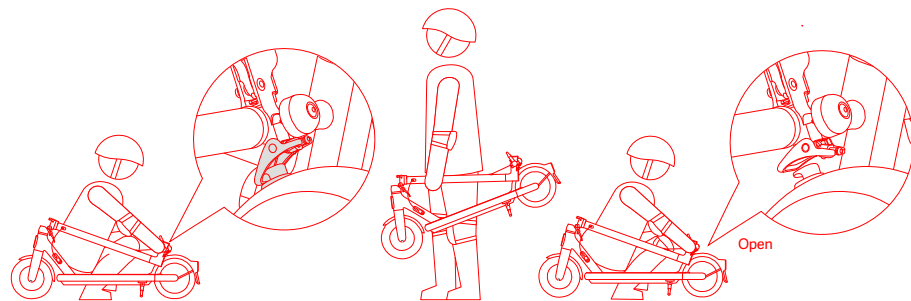

3 Align the bell and the buckle and hook them.

4 Hold the stem with either one hand or both hands to carry.

5 Disengage the bell lever from the buckle on the mudguard.



## Adjust the Disc Brake

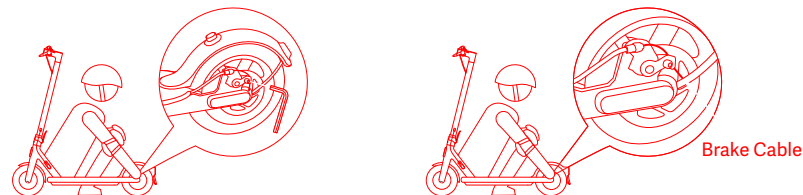

Before adjustment, make sure the scooter is powered off and not charging. If the brake is too tight/loose, use the 4 mm Allen key to loosen the screw on the caliper. Then slightly adjust the brake line (decrease/increase the exposed length), and tighten the screw again.



## Inflate the Tire

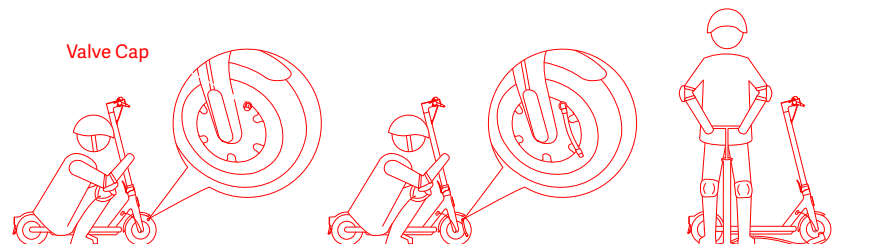

Unscrew the valve cap.

Connect the extension nozzle to the tire valve stem.

Connect the pump to inflate the tire.

Note: please check the tire pressure regularly, and inflate the tire if its pressure is insufficient.

Manufactured for: Xiaomi Communications Co., Ltd.  
Manufactured by: Ninebot (Changzhou) Tech Co., Ltd. (a MI Ecosystem company)  
Address: 16F-17F, Block A, Building 3, No.18, Changwu Mid Rd, Wujin Dist., Changzhou, Jiangsu, China.

Importer:  
Beryko s.r.o.  
Pod Vinicemi 931/2, 301 00 Plzeň  
[www.beryko.cz](http://www.beryko.cz)

Illustrations of product, accessories, and user interface in the user manual are for reference purposes only. Actual product and functions may vary due to product enhancements.

For further information, please go to [www.mi.com](http://www.mi.com)

For detailed e-manual, please go to [www.mi.com/global/service/userguide](http://www.mi.com/global/service/userguide)

